

ZTE



5G Uplink Enhancement Technology **White Paper**

Overview	1
5G calls for enhanced uplink performance	2
Uplink-data-intensive applications call for enhanced capacity of uplink	2
The suboptimal uplink coverage of higher 5G bands needs to be enhanced as well	2
5G Uplink Enhancement Technologies	3
3GPP Rel-15 incorporates multiple uplink enhancement technologies	3
5G Dual Connectivity (EN-DC)	3
5G Carrier Aggregation (CA)	5
5G Supplementary Uplink (SUL)	7
3GPP Rel-16 introduces Uplink Tx Switching to further enhance the uplink performance	9
Uplink Tx Switching maximized resource utilization with respect to UE's capability	9
Uplink Tx Switching (EN-DC)	10
Uplink Tx Switching (UL Inter-band CA)	10
Uplink Tx Switching (SUL)	12
Comparison of the uplink enhancement technologies	13
Overall Architecture Comparison	13
System Performance Comparison	14
Summary	14
Evolution of Uplink Enhancement Technology	15
Multi-Band and Multi-carrier Capabilities of CA	15
NR-NR Dual Connectivity	15
Uplink Enhancement of TDD-TDD with different frame structure	16
Summary and Outlook	17
Abbreviations and Acronyms	18
References	20

Overview

With higher capacity, better reliability and lower latency like no previous generations of mobile technologies ever before, 5G can meet the growing demands for mobile internet and also help modernize a lot of vertical industries such as manufacturing, transportation, energy and health care. As 5G is becoming integrated literally into every aspect of our society, the huge variety of its applications, including the internet of things, cloud storage, high-definition live streaming, etc., calls for outstanding 5G performance particularly in uplink capacity and coverage.

The most popular 5G bands in the world are TDD-NR bands such as 3.5 GHz and 2.6 GHz, which do offer very large bandwidth and therefore high capacity, but can be underperforming in terms of uplink coverage and capacity due to the limitations of mid-band and TDD duplex technology.

It is therefore very important for 5G to improve the performance of uplink in order to realize the potentials of 5G in more applications, better user experience and lower deployment cost.

To tackle these challenges, various 5G uplink enhancement technologies have been developed. This paper discusses these technologies with respect to the development and evolution of 5G standardization, and offers both comparative analysis and outlook of the prospect of uplink enhancement technologies in the future.



5G calls for enhanced uplink performance

The past 30 years have witnessed an astonishing growth of wireless communication industry, from voice-featured 2G, to data-featured 3G/4G, and to 5G era featured by Internet of Everything. As the latest generation of mobile communication technology, 5G is set to empower both people's lives and various industries like never before. In order to realize all these potentials, 5G needs to delivery much better wireless network performance, particularly for uplink.

Uplink-data-intensive applications call for enhanced capacity of uplink

5G network initially focuses on eMBB. While with 5G large-scale commercialization, operators would increasingly turn more of their attention to opportunities in business-to-business markets. The top-quality 5G network should accommodate massive data capacity requirements on the uplink, including HD video, online games, big data collection, intelligent surveillance, AR/VR live video, which demands continuous improvement of network capacity and latency.

Many of the popular 5G frequency bands (such as 3.5GHz

and 2.6GHz) are defined as time division duplex mode (TDD) in 3GPP. With TDD, uplink is separated from downlink by the allocation of different time slot in the same frequency band. For example, for 2.5 ms dual-period frame structure, there are 5 downlink timeslots, 3 uplink timeslots and 2 special timeslots in the timespan of 5 ms. Approximately 30% of timeslots are used for uplink. Taking 100 MHz bandwidth as an example, the equivalent uplink bandwidth is only 30 MHz, which is only 1.5 times that of the 4G single carrier. Therefore, it can be difficult to meet the increasing uplink capacity requirements.

The suboptimal uplink coverage of higher 5G bands needs to be enhanced as well

As most low-range bands have been allocated to 2G/3G/4G mobile communication networks or other systems, 5G spectrum mainly located in the mid-bands, including 3.5 GHz and 2.6 GHz. Due to the nature of radio signal propagation, the higher frequency band is, the higher path loss and penetration loss it has, which further limits the coverage. For example, at the same distance, the path loss of 3.5GHz is 4.4 dB higher than that of 2.1 GHz, and in outdoor-to-indoor scenario, where wireless signals penetrate through glass windows or walls to reach indoor users, the penetration loss of 3.5 GHz is about 3 dB higher than that of 2.1 GHz.

Although advanced technologies such as Massive MIMO have been introduced into 5G network to offset the propagation loss to some extent, the coverage of the mid-bands is still weaker than that of low-bands. To deploy 5G network only with mid-bands can result in higher TCO.

Therefore, from the perspective of service development and network deployment, it is critical to improve 5G uplink performance to ensure diversified services development, guarantee user experience, and reduce deployment cost.

5G Uplink Enhancement Technologies

3GPP (Third Generation Partnership Project) has been focusing on the uplink enhanced technology in the 5G NR standards. In 3GPP Release15 and Release16, a variety of uplink enhancement technologies have been defined and enhanced, such as increasing the transmit power of the terminal and introducing long-PUCCH. This paper focuses on how to leverage multiple frequency bands for uplink enhancement in the context of 3GPP standard evolution.

3GPP Rel-15 incorporates multiple uplink enhancement technologies

There are three uplink enhancement technologies in 3GPP Release 15: E-UTRA-NR Dual Connection (EN-DC), Carrier Aggregation (CA), and Supplementary Uplink (SUL).

5G Dual Connectivity (EN-DC)

1 Technical Principle

To launch 5G services more swiftly and more cost-effectively, some operators leverages the existing LTE radio access and core network (EPC) to anchor 5G NR using the Dual Connectivity feature. When radio access network is composed of eNBs as the master node and

gNBs as the secondary node, it is called EN-DC (E-UTRA-NR Dual Connectivity). With EN-DC, UE can transmit data either under only LTE or under both LTE and NR radio coverage. Therefore, the coverage problem of users at the edge of the cell can be well solved.

Note 1: In this paper, to ensure the analysis and comparison with the same basis, the FDD-NR frequency band (2.1 GHz, bandwidth 20 MHz) and 3.5 GHz (bandwidth 100 MHz) are used unless otherwise specified. In addition, the 2.5 ms dual-period frame structure is used for analysis and explanation.

Note 2: Although certain FDD and TDD carrier coordination technologies are discussed in this paper, the list of carrier types is by no means exhaustive. For the duplex modes and frequency bands involved in each technology, please refer to the definition in 3GPP.

2 Application Scenarios

Due to the difference between 4G coverage and 5G coverage, the applicable scenarios of EN-DC are shown in the following.

In area A, because there are both 4G and 5G coverage, UE capable of EN-DC can transmit data by 4G and 5G network. As the commercial terminal generally supports 2 transmission channels (2Tx), one Tx can be used for LTE and the other for 5G NR.

In area B, because there is only 4G coverage, UE can only transmit data via LTE.

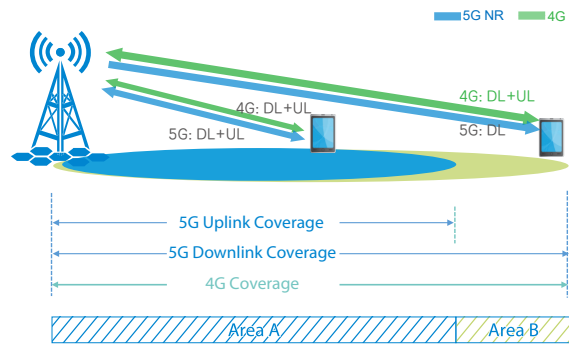

Figure 2-1 Application Scenario of EN-DC

The following figure shows the uplink operating modes of UEs in areas A and B.

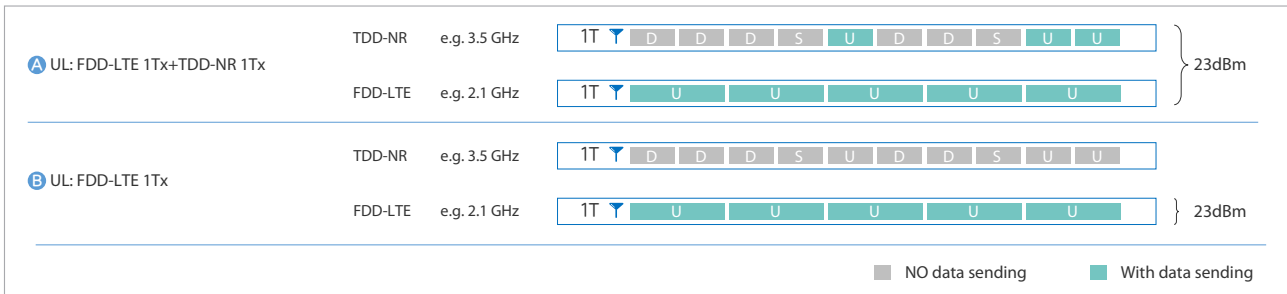

Figure 2-2 Uplink operating mode of UE with EN-DC

3 Performance Analysis

Single-User Peak Throughput

Mobile devices supporting EN-DC will have two concurrent radio connections to the EPC, one of which is via 5G NR and the other via LTE. However, because UE uses one Tx for 5G NR, the uplink dual-stream capability of 5G NR is limited, which means peak uplink data throughput only 74% of what can be achieved in 5G SA.

Coverage

In areas without 5G coverage, LTE is used to send data in the uplink, so although the uplink coverage of 5G is not actually improved, the coverage area from the user's perspective is extended.

In general, with NSA architecture, 5G uplink throughput is improved compared with 4G, yet still lower than 5G SA. The coverage of 5G NR is not improved, but in areas without 5G coverage where both signaling and traffic can be transmitted over 4G, user experience is not significantly deteriorated compared with that of 4G network.

5G Carrier Aggregation (CA)

1 Technical Principle

The Carrier Aggregation (CA) technology aggregates the spectrum resources of the same frequency band or different frequency bands to better utilize network resources and also improve user experience.

NR CA can be classified as intra-band CA and inter-band CA. NR intra-band carrier aggregation operates in the same operating bands and NR inter-band carrier aggregation operates in the different operating bands.

Intra-band Carrier Aggregation (Intra-Band CA)

Intra-band CA is to aggregate multiple carriers in the same operating band. 3GPP Rel-15 defines multiple intra-band CA operating bands, including n77, n78, and n79.

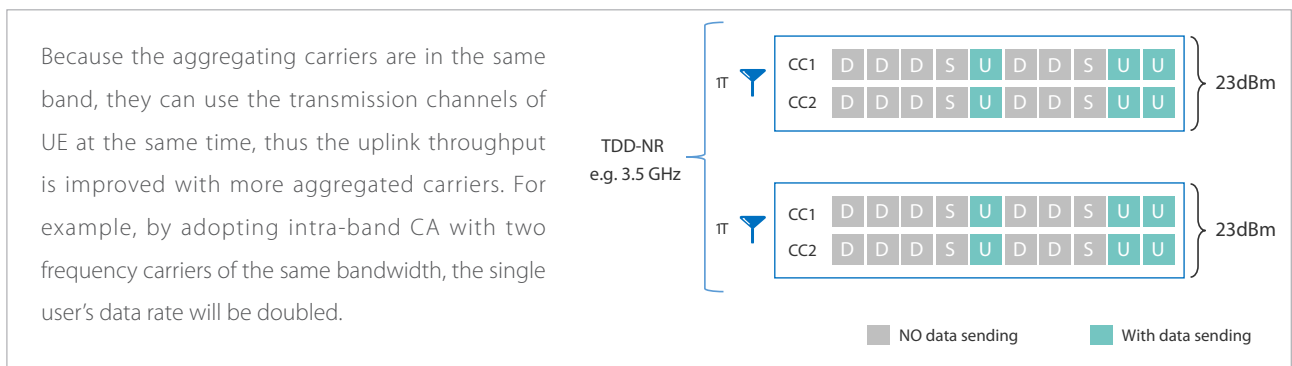

Figure 2-3 5G Rel-15 UE uplink operating mode with UL CA (Intra-Band)

Inter-Band Carrier Aggregation (Inter-Band CA)

Inter-band carrier aggregation aggregates the carriers of different operating bands. In 3GPP Rel-15 defines 13 Inter-band CA operating bands involving FR1 [1], such as CA_n3-n78, CA_n28-n78, etc.

At the area where the two aggregating carriers' coverage is good, uplink CA can be used to improve spectrum utilization. However, as most mobile devices support two transmission channels (2Tx), two transmission channels are to support two carriers respectively, so UL CA will restrain the uplink dual-stream capability on TDD-NR which may result in capacity loss .

Application Scenarios

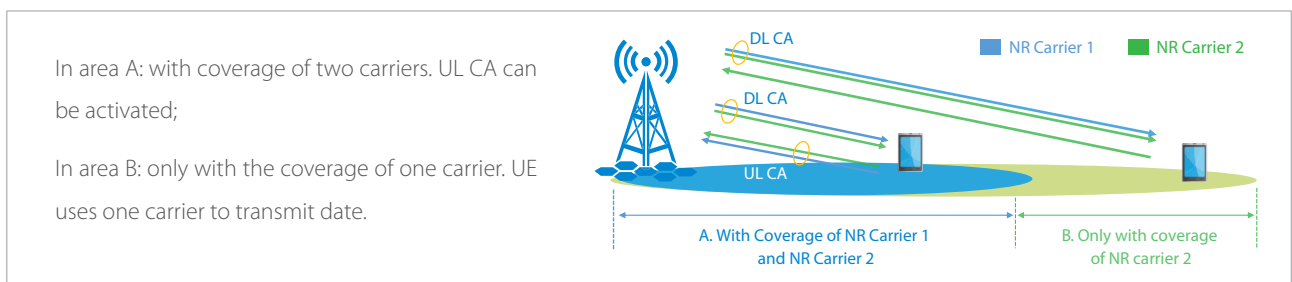

Figure 2-4 Application scenario of UL inter-band CA

In areas A and B, the uplink operating modes of UEs are as following:

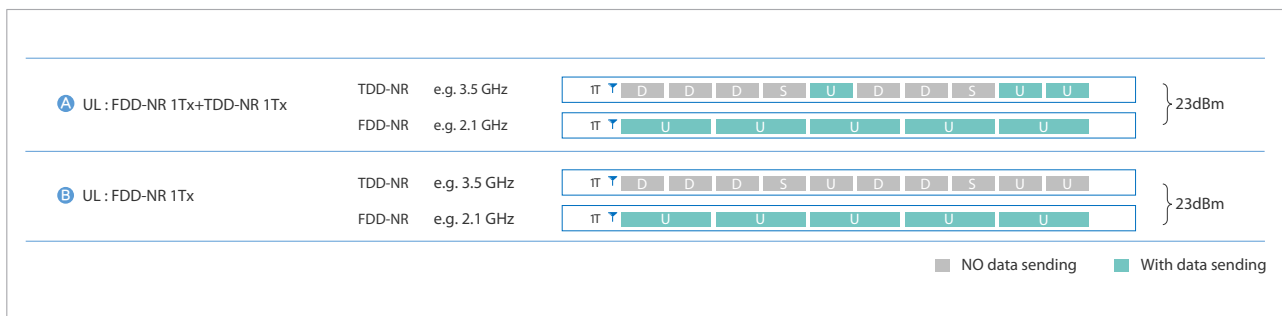

Figure 2-5 Uplink operating mode of UE with EN-DC

Performance Analysis

Single-User Peak Throughput

Since UL inter-band CA cannot use uplink dual streams, it may have a negative impact on capacity. For example, when 2.1 GHz (20 MHz bandwidth) and 3.5 GHz (100 MHz bandwidth) are aggregated, the uplink peak data rate of a single user drops to 80% of that with 3.5 GHz in SA mode. In this case, gNodeB will NOT activate uplink CA but single-carrier mode to maximize the resource utilization.

It must be clarified that NOT in all scenarios will UL CA have the negative impact on capacity. The single user's uplink throughput of CA is directly related to the bandwidth and uplink duty ratio (of TDD-NR carrier) of the two aggregated component carriers (CC1 and CC2). For example, when CC1 is a TDD-NR carrier (bandwidth of 50 MHz and 2.5 ms dual-period frame structure), and CC2 is an FDD-NR carrier (bandwidth of 20 MHz). The uplink peak throughput of UL CA is increased by about 8% compared to that of TDD-NR single-carrier of dual-stream.

Coverage

FDD-NR usually adopts medium- or low-range bands offering better uplink coverage than TDD-NR. Therefore, FDD-NR can be used to provide 5G services beyond the TDD-NR coverage area to improve user experience. For example, when the uplink data rate at cell edge is 2Mbps, if FDD-NR 2.1 GHz (20 MHz bandwidth) and TDD-NR 3.5 GHz (100 MHz bandwidth) are aggregated, the coverage can be improved by 17.8% compared with SA-based TDD-NR single carrier.

CA technology was introduced from the 4G era and has been successfully deployed and commercialized worldwide. NR CA has been included since 3GPP Rel-15. Intra-band CA can aggregate multiple frequency carriers of the same band and improve user experience. However, the throughput of inter-band CA can be limited in some cases by the number of transmission channels of terminals.

5G Supplementary Uplink (SUL)

1 Technical Principle

Supplementary uplink (SUL) is introduced in 3GPP Rel-15 to extend the uplink coverage by providing a supplementary uplink (usually in sub-3 GHz band). With SUL, a DL frequency band (NR frequency band) and two uplink frequency bands (one NR frequency band and one SUL frequency band) are configured in the same cell.

When the uplink coverage of the NR carrier is good, UE uses the NR carrier to send and receive data. When the UE is moving beyond the uplink coverage of the NR carrier, UE uses the SUL carrier for transmitting data. UE can dynamically select the UL NR or SUL for data transmission, but cannot use the two carriers at the same time.

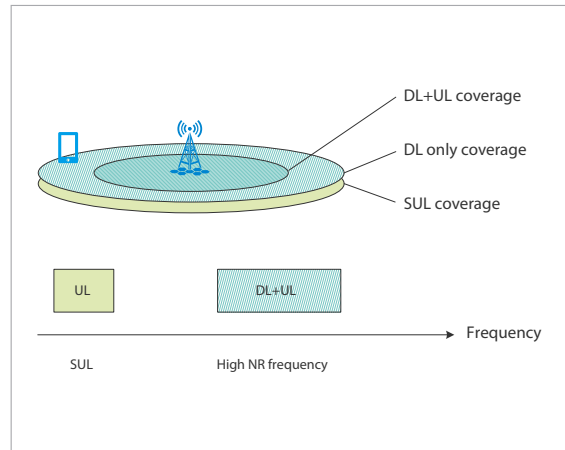

Figure 2-6 Diagram of supplementary uplink

3GPP Rel-15 defines the SUL frequency range.

Operating bands for SUL			
NR frequency band	Uplink operating band	Downlink operating frequency band	Duplex mode
n80	1710 MHz - 1785 MHz	N/A	SUL
n81	880 MHz - 915 MHz	N/A	SUL
n82	832 MHz - 862 MHz	N/A	SUL
n83	703 MHz - 748 MHz	N/A	SUL
n84	1920 MHz - 1980 MHz	N/A	SUL
n86	1710 MHz - 1780 MHz	N/A	SUL

Definition of Corresponding NR/LTE	
NR/LTE frequency band	Uplink operating band
n3/b3	1710 MHz - 1785 MHz
n8/b8	880 MHz - 915 MHz
n20/b20	832 MHz - 862 MHz
n28/b28	703 MHz - 748 MHz
n1/b1	1920 MHz - 1980 MHz
n66	1710 MHz - 1780 MHz

Table 2-1 NR operating band for SUL

The uplink operating bands of SULs are defined same to that of the corresponding FDD-LTE/FDD-NR operating bands, and need to be shared with the existing network (4G or 5G).

The SUL bands only involves uplink, so it cannot be used alone. Therefore, 3GPP Rel-15 defines the 8 combinations of SUL and NR bands [1], including the combined definition of n78, n79 and SUL bands.

2 Application Scenarios

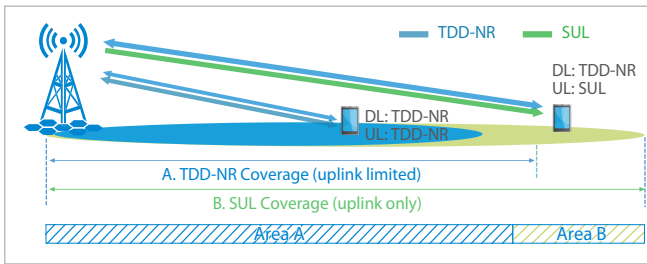

The application scenario of SUL is shown in the figure below:

Area A: with the good coverage of TDD-NR, UE uses TDD-NR for data transmitting.

Area B: beyond the uplink coverage of TDD-NR, UE switches to the SUL band for data sending.

Figure 2-7 Application scenario of SUL

UEs have the following operating modes in areas A and B:

A UL: TDD-NR 2Tx	TDD	e.g. 3.5 GHz		} 23dBm
	SUL	e.g. 2.1 GHz		
B UL: SUL 1Tx	TDD-NR	e.g. 3.5 GHz		} 23dBm
	SUL	e.g. 2.1 GHz		

■ NO data sending ■ With data sending

Figure 2-8 uplink operating mode of UE with SUL

3 Performance Analysis

Single-User Peak Throughput

In TDD-NR coverage areas, TDD-NR will be used to send and receive data, so SUL will NOT influence the single user's peak throughput.

Coverage

Generally, SUL adopts sub-3 GHz bands with better uplink coverage than TDD-NR bands, therefore improves user experience. For example, in dense urban areas where cell edge uplink data rate is 2Mbps, if SUL 2.1 GHz (bandwidth of 20 MHz) and TDD-NR 3.5 GHz (bandwidth of 100 MHz) are deployed for networking, the network coverage can be increase by 17.8% compared with that of TDD-NR single-carrier and SA architecture.

The downside of SUL is that it makes general 5G NR bands and SUL bands more dependent on one another which limits its applicability for the following reasons:

TDD-NR DL/UL and SUL have to be in the same cell, which is not the case for CA. Therefore, SUL cannot support inter-cell and inter-site uplink coverage enhancement.

Even when TDD-NR and SUL are indeed in the same cell, they have to have the same engineering parameters and same coverage, which is hard to achieve in real-life network.

SUL technology improves the uplink coverage by using sub-3 GHz bands for uplink transmission. SUL defines new paired spectrum between TDD-NR and SUL and SUL is obtained by sharing the spectrum with 4G network. Therefore, 5G must be co-sited with 4G which limits the flexibility of 5G deployment and brings new problems to network deployment.

3GPP Rel-16 introduces Uplink Tx Switching to further enhance the uplink performance

In 3GPP Release 16, UL Tx Switching is introduced as a new feature to enhance EN-DC, CA and SUL.

Uplink Tx Switching maximizes resource utilization with respect to UE's capability

Limited by the complexity of antenna design and low transmission power of UE, 5G terminals generally have only two transmission channels (2Tx) for uplink, which decreases the spectrum resources utilization efficiency in multi-carriers networking:

- With EN-DC, there is only one transmission channel for NR which makes dual-stream transmission on uplink impossible.
- With intra-band CA, the throughput is proportional to the total bandwidth. However, with inter-band CA, each carrier can only use one transmit channel, which makes it impossible to do the dual-stream transmission on uplink, resulting in capacity loss.
- Although the uplink dual-stream capability of the TDD-NR carrier is maintained with SUL, the SUL frequency band is not utilized near the cell tower.

In response to these challenges, Uplink Tx Switching is introduced in 3GPP Rel-16. It uses one transmitting channel either for carrier 1 or carrier 2, and uses the other transmitting channel exclusively for carrier 2:

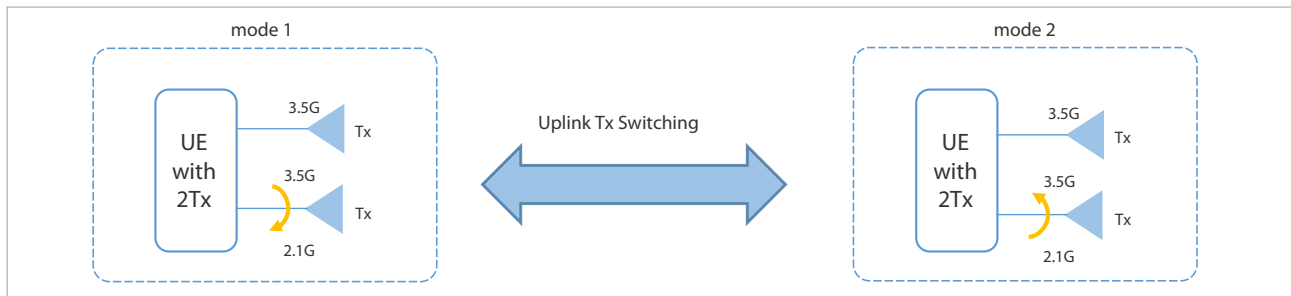

Figure 2-9 Uplink Tx Switching

mode 1: One transmitting channels is used for 2.1GHz, and the other is for 3.5 GHz.

mode 2: One transmitting channel is switched to 3.5 GHz, and the other is still used for 3.5 GHz, which supports TDD-NR dual stream transmission .

When switching between mode 1 and mode 2, Uplink Tx Switching is activated.

As UE capabilities vary from terminal to terminal, Option 1 and Option 2 are further defined in Rel-16:

Option 1: UE can send data over Carrier 1 and Carrier 2 in time division mode, but not at the same time (referred to as TDM mode).

Option 2: On the terminal side, Carrier1 and Carrier2 can be flexibly aggregated, either in time division mode or simultaneous transmission mode (referred to as TDM + Concurrent mode).

	Antenna Tx Mode	Number of UL Tx antenna ports
mode 1	1T+1T	1P+0P
mode 2	0T+2T	0P+2P, 0P+1P

	Antenna Tx Mode	Ports number of UL Tx antenna
mode 1	1T+1T	1P+0P, 1P+1P, 0P+1P
mode 2	0T+2T	0P+2P, 0P+1P

Uplink Tx Switching (EN-DC)

With Uplink Tx Switching (EN-DC), in the uplink time slots for TDD-NR, the Tx channels that originally supported LTE are switched to the TDD-NR frequency band, so that UE can use dual-stream in uplink, and in other time slots, the Tx are switched back to LTE. With regard to factors of the UE capabilities and wireless environment, UE can work in different modes as follows:

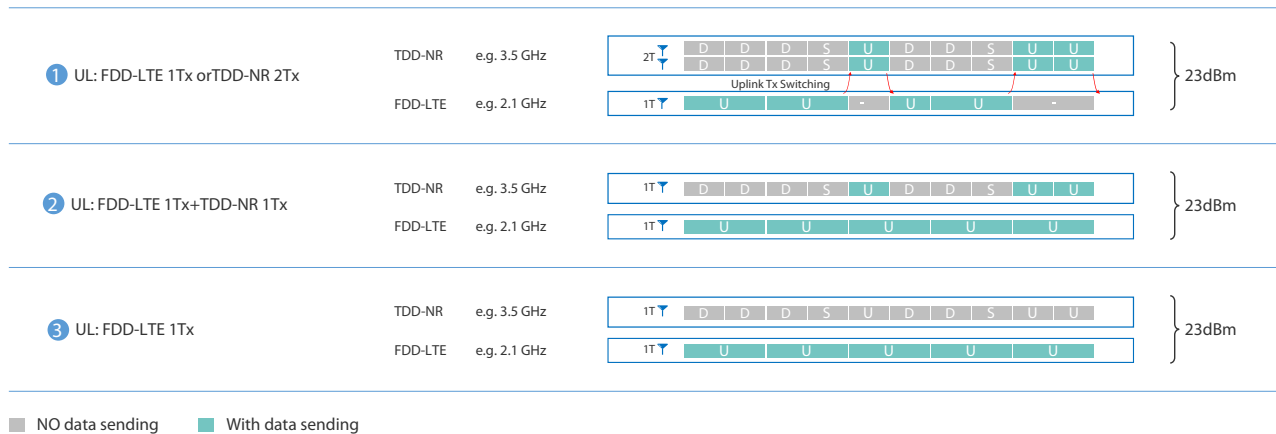

Figure 2-10 uplink operating modes of UE with Uplink Tx Switching (EN-DC)

Uplink Tx Switching is used to enhance the uplink capacity:

With Uplink Tx Switching, in the uplink time slots for TDD-NR, dual-stream is maintained, and in other time slots UE uses the traditional EN-DC mode, resulting the uplink peak throughput increased by about 17% than that of TDD-NR in SA architecture.

Uplink Tx Switching (UL Inter-band CA)

With Uplink Tx switching activated for inter-band CA, in TDD-NR UL time slots UE can transmit data with dual-stream. Its typical application is shown as below:

When close to cell tower, UE can use inter-band CA with uplink Tx switching to further improve capacity and reduce latency.

At cell edge, UE uses FDD frequency band to send data, while maintaining FDD and TDD carrier aggregation in downlink, improving user experience.

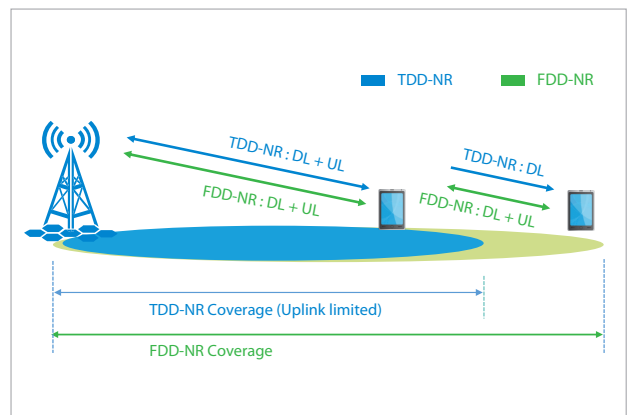

Figure 2-11 Application Scenario of UL CA with Uplink Tx Switching

Inter-band CA can flexibly support Option 1 and Option 2 of uplink Tx switching. UE can work in one of the following modes depending on the UE capabilities and the radio environment:

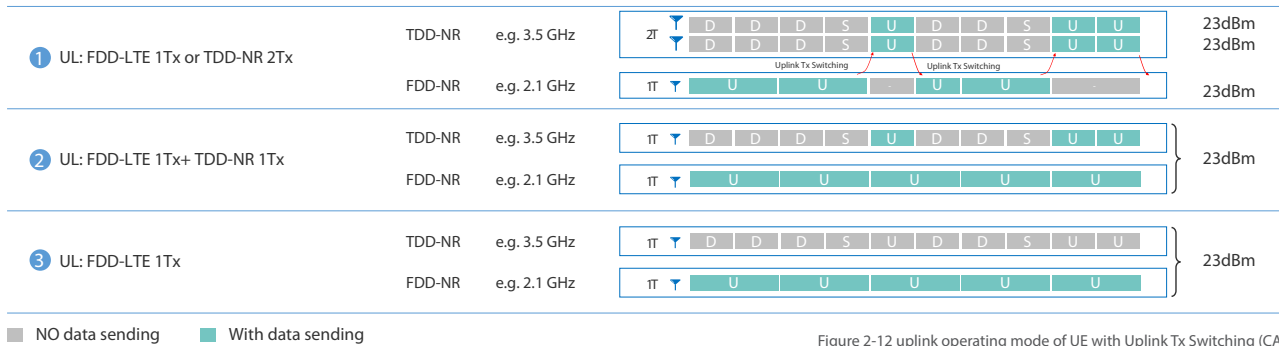

Figure 2-12 uplink operating mode of UE with Uplink Tx Switching (CA)

In addition, 3GPP Rel-16 has expanded the frequency band combinations of carrier aggregation to 78 [1], and by integrating with Uplink Tx Switching, CA can boost 5G performance in coverage, capacity and latency.

Coverage improvement

With Uplink Tx Switching, UE can connect to both FDD and TDD carriers at the same time, even at cell edge, which solves the issue of no 5G access due to limited uplink.

For example, in case of TDD-NR with 3.5 GHz and a bandwidth of 100 MHz, and FDD-NR frequency band of 2.1 GHz utilized for carrier aggregation, when cell edge uplink data rate is 2Mbps, adopting CA with Uplink Tx Switching can increase network capacity by 17.8%, compared to the network with only single-carrier TDD-NR.

Uplink throughput improvement

In the case of TDD-NR with 3.5 GHz (bandwidth of 100 MHz) aggregates FDD-NR of 2.1 GHz (bandwidth is 20 MHz) with Uplink Tx Switching, uplink peak throughput capacity is improved by 20%.

Latency reduction

Uplink Tx Switching can increase uplink time slot availability to 100%, therefore HARQ RTT can be reduced by 25% without uplink data having to waiting for TDD-NR uplink timeslots.

3GPP Rel-15 introduces inter-band CA with concurrent transmission on two carriers which may result in capacity loss without TDD-NR's dual-stream transmission on uplink. While with Uplink Tx Switching, this limitation has been eliminated by sending data on FDD-NR and TDD-NR carriers with TDM mode. CA with Uplink Tx Switching maximizes spectrum utilization in both time domain and frequency domain, and by integrating with the feature of power boosting on TDD-NR carrier to achieve better user experiences.

Uplink Tx Switching (SUL)

With Uplink Tx Switching, SUL can integrate both TDD-NR and SUL's time-frequency resources within TDD-NR's coverage area, thereby increasing uplink capacity. The typical application is shown in the figure :

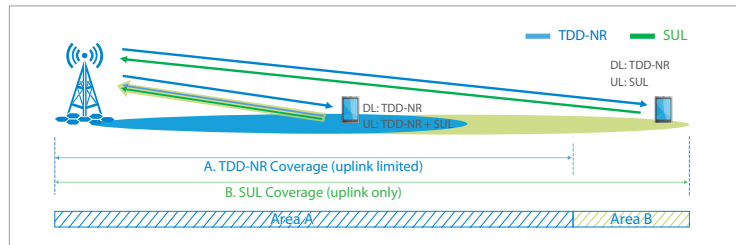

Figure 2-13 Application scenario of SUL with Uplink Tx Switching

SUL only supports Option 1 (TDM mode) with uplink Tx switching. Depending on the wireless environments, UE operates in the following modes:

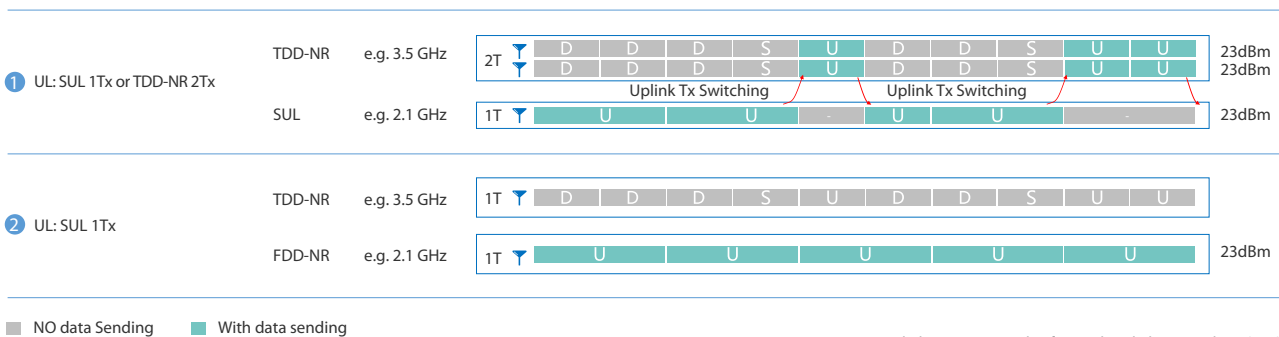

Figure 2-14 plink operating mode of UE with Uplink Tx Switching (SUL)

When close to cell tower, UE switches between TDD-NR and SUL frequency bands for data transmission. At cell edge, SUL carrier is used to provide uplink coverage.

Therefore, SUL with Uplink Tx Switching improves uplink throughput and reduces latency, and cannot improve the coverage compared with SUL without Uplink Tx Switching.

With Uplink Tx Switching, uplink time-frequency resources of SUL can be allocated for UE, and single user's uplink capacity can be increased by 20%.

Up to 100% of the uplink time slots can be available, and HARQ RTT can be reduced by nearly 20%.

Although the 3GPP Rel-16 enhances the performance of SUL by using Uplink Tx Switching, it's still required SUL and TDD-NR to be tightly coupled in the same cell, which poses further challenges to deployment, including engineering configuration for the RF equipment's of TDD-NR and the SUL. In addition, since SUL is tightly coupled with TDD-NR, it cannot support flexible scheduling among different cells, different sites, and among macro and micro sites.

Comparison of the uplink enhancement technologies

Overall Architecture Comparison

The limited uplink coverage has become a key bottleneck for deploying 5G network with TDD-NR (3.5 GHz or 2.6 GHz, for example). To address this issue, three solutions, including dual connectivity (EN-DC), carrier aggregation (UL CA) and supplementary uplink technology (SUL), are first introduced in 3GPP Rel-15, and then enhanced in Rel-16 with Uplink Tx Switching.

- EN-DC is the main system architecture in the initial stage of 5G deployment. But, it can be complex for devices to support dual connection with no plan in sight to support Uplink Tx Switching.
- CA with Uplink Tx Switching has already been verified and has much better support of the ecosystem.
- SUL is a new 5G feature and has a long way to go in terms of ecosystem. Moreover, due to the tight coupling of SUL and NR carriers, inter-cell and inter-site operation are not supported, which limits the flexibility of its deployment.

	EN-DC	UL CA	SUL	EN-DC with UL Tx Switching	UL CA with UL Tx Switching	SUL with UL Tx Switching
3GPP Standards	Rel-15	Rel-15	Rel-15	Rel-16	Rel-16	Rel-16
Application/Industry Maturity	★★★★★	★★★	★★	★	★★★	★★
Cross-site and cross-cell capabilities	★★★★★	★★★★★	★★	★★★★★	★★★★★	★★

Table 2-2 Comparison of uplink enhancement technologies



System Performance Comparison

The following comparison of system performance enhancements is based on 2.1 GHz (20 MHz bandwidth) + 3.5 GHz (100 MHz bandwidth).

	Baseline	3GPP Rel-15			3GPP Rel-16		
	TDD-NR(Single Carrier, SA)	EN-DC	UL CA	SUL	EN-DC with UL Tx Switching	UL CA with UL Tx Switching	SUL with UL Tx Switching
Enhancement on 5G Uplink Coverage	A	1.18*A	1.18*A	1.18*A	1.18*A	1.18*A	1.18*A
Enhancement on 5G Uplink Peak Throughput	B	0.74*B	B	B	1.17*B	1.2*B	1.2*B
Reduction on HARQ RTT	C	0.75*C	0.75*C	0.8*C	0.75*C	0.75*C	0.8*C
Enhancement on 5G Downlink Peak Throughput	D	1.25*D	1.29*D	D	1.25*D	1.29*D	D

Table 2-3 Performance comparison of uplink enhancement technology

Summary

Network rollout strategy, spectrums development planning and expansion to vertical markets are all crucial to operators' network and business development. While the global 5G market is still in the early stages of development, operator should secure a solid foundation for more sustainable growth.

Ecosystem is the key to technology uptake. Standards, evolution capability and capability of the related network elements (CN, RAN and UE) will all have an impact on 5G commercialization progress, which is why carrier aggregation is the better option that the operators can instantly benefit from.

Uplink Enhancement Technology should be flexible to deploy whether 4G and 5G are co-located in the same site or not. With 5G rollout being accelerated, 5G is increasingly deployed with co-locating with NO 4G. Uplink enhancement technologies must support flexible scheduling and coordination among multiple frequency bands and multiple sites. However, SUL further couples NR and SUL frequency bands, therefore does not support inter-cell and inter-site coordination and limits its applicability.

Network capacity, coverage, and reliability are becoming increasingly important to subscribers. SUL enhances uplink coverage and performance, but with decoupling of uplink and downlink, it does not improve downlink capacity, whereas CA can simultaneously improve the capacity and coverage of uplink and downlink, achieving the best user experience.

Therefore, CA with Uplink Tx Switching can boost the system performance of uplink coverage, uplink and downlink capacity, and reduce latency, and is the best choice for 5G uplink enhancement technology.

Evolution of Uplink Enhancement Technology

As new NR spectra are made available and low-band spectra are reformed or shared with 5G, 5G networks are required to harmonize the use of spectrum bands to provide cost-efficient and competitive services.

To further realize the potentials of these spectrum resources, it is crucial to ensure uplink performance of 5G can be enhanced. In order to achieve this, we believe that 5G uplink enhancement technologies should be evolved in the following ways:

Multi-Band and Multi-carrier Capabilities of CA

The larger bandwidth of FDD-NR further empowers network performance with carrier aggregation.

In 3GPP Rel-16, the bandwidth of FDD-NR is increased. For example, the bandwidth in 1.8 GHz band now includes 30 and 40 MHz, and bandwidth in 2.1 GHz band includes 25, 30, 40, and 50 MHz. Intra-band and Inter-band carrier aggregation can support these new bandwidth types to further improve user throughput.

CA can combine multi-band and multi-carrier, all based on off-the-shelf technologies.

In 3GPP Rel-16, the number of inter-band CA's operating bands is not limited to two, as carrier aggregation of three bands and four bands are all defined which gives 5G deployment even more options and flexibility.

NR-NR Dual Connectivity

Similar to EN-DC, UE can also establish dual connections with two NR base stations (NR-DC, NR-NR Dual Connectivity) in 5G SA architecture. When the frequency bands of the two NR differ greatly (for example, middle band and high band of mmWave), the middle band can improve the uplink of the higher band. CA with Uplink Tx Switching can be applied NR-DC to improve uplink capacity.

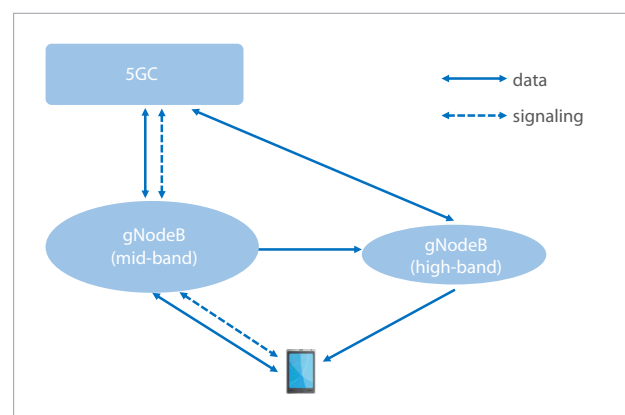

Figure 3-1 NR-DC system architecture

Uplink Enhancement of TDD-TDD with different frame structure

As TDD bands have fewer uplink time slots, their uplink capacity and coverage are limited. If two TDD frequency bands use different frame structures, carrier aggregation with Uplink Tx Switching and frame misaligned can be combined so that all the uplink time slots can be used to increase uplink performance. For example, if 5ms period frame structures (DDDDDSUU, uplink proportion of 20%) and 2.5ms period frame structure (DSUUU, uplink proportion of 60%) are used, , after aggregation, the available uplink timeslots within 5 ms can be increased to 80%.

With CA combined with Uplink Tx Switching and frame misaligned, not only can the uplink timeslot ratio within 5ms be increased, but also at the same time dual-stream on each TDD carrier is maintained which maximizes the time-frequency resources utilization efficiency.

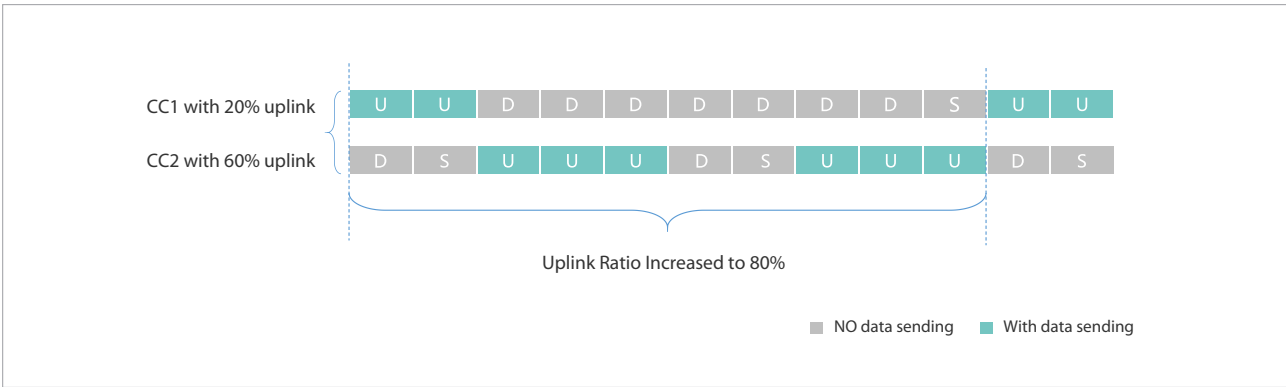

Figure 3-2 UE uplink operating mode with TDD-TDD CA with different frame structures



Summary and Outlook

3.5 GHz band and 2.6 GHz, two popular TDD-NR bands, have been widely adopted for initial 5G deployment, but their coverage are not as good as those of FDD bands such as 1.8 GHz and 2.1 GHz because of higher propagation loss, higher penetration loss, and lower uplink ratio. So it can be challenging to deploy an evolution-oriented 5G SA network leveraging top-quality and low cost based on just 3.5 GHz or 2.6 GHz.

To address this issue, many solutions have been proposed in the industry but most are not yet up to the task, CA with Uplink Tx Switching, on the other hand, based on the mature carrier aggregation framework, can enhance the aggregation capability of 5G NR carriers in both time and frequency domain to improve coverage, capacity and reduce latency, thus it is the best uplink enhancement solution to deploy a top-quality 5G SA New Radio network with contiguous coverage, low latency and high DL/UL capacity.



Abbreviations and Acronyms

Acronyms	Acronyms
3GPP	Third Generation Partnership Project
5G	Fifth Generation
AR	Augmented Reality
CA	Carrier Aggregation
DL	Downlink
eMBB	Enhanced Mobile Broadband
EN-DC	E-UTRA-NR Dual Connectivity
EPC	Evolved Packet Core
EUTRA	Evolved-UMTS Terrestrial Radio Access
FDD	Frequency-division Duplex
FHD	Full High Definition
FR1	Frequency Range 1
FR2	Frequency Range 2
Massive MIMO	Massive Multiple Input Multiple Output



Acronyms	Acronyms
NR-DC	NR-NR Dual Connectivity
NR	New Radio
NSA	Non-Standalone
PUCCH	Physical Uplink Control Channel
Rel-15	3GPP Release 15
Rel-16	3GPP Release 16
SA	Standalone
SUL	Supplementary Uplink
TDD	Time Division Duplex
TDM	Time Division Mode
Tx	Transmitter
UL	Uplink
UL CA	Uplink Carrier Aggregation
uRLLC	Ultra-reliable and Low Latency Communications
VR	Virtual Reality



References

[1] 3GPP TS 38.101-1

"NR; User Equipment (UE) radio transmission and reception;
Part 1: Range 1 Standalone"

[2] 3GPP TS 38.213

"NR; Physical layer procedures for control".

[3] 3GPP TS 38.214

"NR; Physical layer procedures for data".

ZTE Corporation. All rights reserved.

The copyright of this document is vested in ZTE Corporation. Proprietary information of ZTE Corporation involved in this document. Without written permission of ZTE Corporation, no order is available.

No bit or individual is allowed to use or disclose this document or any pictures, tables, data, or other information contained in this document.

The information in this document will be continuously updated with the improvement of ZTE Corporation products and technologies, and the ZTE Corporation will not notify the update of such information.